



EVERLAST

SAW OF NORTH AMERICA

PRODUCT CATALOGUE

CARBIDE TIPPED CIRCULAR SAW BLADES

Everlast Saw	1
Safety and Sawing with Carbide Tips	1
Cutting Speeds for Various Materials.....	1
Saw Blade Design Elements.....	2
Standard Top Grinds.....	3

Products – Page Number Listing

Rip - Glue Line & Heavy Duty.....GL, HD	4
Astra Series Table Saws..... AGP.....	5
General Purpose Cut-Off..... GP.....	5
Combination Saws	CBS.....5
Standard Purpose Cut-off..... SP	6
Special Purpose Cut-off	SPE.....6
Plastic - Vinyl - Plex-Cut..... PC, PLJ.....	7
Double Cut-off & Trim	DCO
Thin Rim, Thin Kerf	TR, TK.....8
Astra Mitre Saws	AS.....8
Radial Overarm	RO.....9
Mitre Saws.....	MT.....9
Double Faced Laminate	DFL.....10
Double Faced Veneer	DFV.....10
Steel-Kut.....	JEP.....10
Non-Ferrous Metal.....	NF.....11
Astra Series Panel Saws.....	AS.....12
Astra Scoring Saws, Split Scoring Saws.....	AS.....12
Track Saw Blades	FT.....13
Countertop.....	CT.....13
Astra Solid Surface.....	DFLC.....13
Dado Sets - Outside Saws - Chippers	DS, OS, DC.....14
Pallet/Nail Cutting Blades.....	PL.....14
Groovers.....	GRO.....15
Edge Bander	EB.....15
Biscuit Cutter	LAM.....15
Tree Saws, Slot Cutters	TRE, EGS.....16
Truss and Component Saws.....	TC.....17

Products – Saw Type Listing

Astra Series Table Saws.....	AGP.....5
Biscuit Cutter	LAM.....15
Combination Saws	CBS.....5
Countertop.....	CT.....13
Dado Sets - Outside Saws - Chippers	DS, OS, DC.....14
Double Cut-off & Trim	DCO
Double Faced Laminate	DFL.....10
Double Faced Veneer	DFV.....10
Edge Bander	EB.....15
General Purpose Cut-Off.....	GP.....5
Groovers.....	GRO.....15
Mitre Saws.....	AS.....8
Mitre Saws.....	MT.....9
Non-Ferrous Metal	NF.....11
Pallet/Nail Cutting Blades.....	PL.....14
Panel Saws	AS.....12
Plastic - Vinyl - Plex-Cut.....	PC, PLJ.....7
Radial Overarm	RO.....9
Rip - Glue Line & Heavy Duty.....	GL, HD.....4
Scoring Saws - Split Scoring Saws.....	AS.....12
Solid Surface	DFLC.....13
Special Purpose Cut-off	SPE.....6
Standard Purpose Cut-off.....	SP.....6
Steel-Kut.....	JEP.....10
Thin Rim - Thin Kerf	TR, TK.....8
Track Saws.....	FT.....13
Tree Saws, Slot Cutters	TRE, EGS.....16
Truss and Component Saws.....	TC.....17

BALL BEARINGS, SHIMS & DIAMOND GRINDING WHEELS

Ball Bearings, Shims	16
Diamond Grinding Wheels	16

Warranty

Everlast Saw of North America (hereinafter) "we", "our", and "us") warrants each tool to be free of defects at the time of manufacture and, within the limits of our control, for the normal life of the tool, provided the tool has not been misapplied or misused. This warranty does not extend to any tool which has been worn out or made dull from extended use or which has been altered or modified by sharpening or other servicing performed on the tool by a facility other than our own. Any tool believed to be a defective OR that has experienced damage during shipping should be returned to us within five (5) business days of receipt using the original shipping materials (unless directed by Everlast to do otherwise), postage prepaid, for our inspection so that we may determine whether or not a defect exists. Claims for shipping damage must include photos of the package as it was received along with photos of the damaged tool. If we determine a tool to be defective, we will repair or replace it, at our option. We disclaim responsibility for any incidental or consequential damages arising from the failure of any tool to conform to this warranty or other standards. The above warranty is in lieu of all other warranties express or implied. Everlast is continuously involved in research to upgrade the quality and productivity of its tools, and users are invited to contact Everlast for information about the most up-to-date developments and improvements in its tool technology.

© Copyright 2019 Everlast Saw of North America. Specifications and pricing subject to change without notice.

Everlast Saw – A Tradition of Quality & Customer Service

Since 1947, Everlast Saw has been producing quality products for industrial use. Originally founded in New York, Everlast production moved to Naples, FL, in 1998 and then to Kansas in early 2017. This central location provides fast access to customers throughout the USA.

Our mission is simple: Provide the highest quality standard and special cutting tools to our customers in a timely manner. Further, we supply our products only to distributors and promise not to compete with them. In the changing market place, we believe the distributor is an important component as they provide valuable sharpening and consulting services which simply cannot be duplicated when purchasing on-line.

With the start of 2019, we continue to add new products that our customers have requested: Larger diameter saws, Track Saws, Truss and Component Saws and Tree Trimming Saws.

We take great pride in our manufacturing processes that allow us to reliably provide high-quality products to our customers and their customers.

And we are proud to say: Since 1947, Materials from around the World, Quality Made in America.

Safety and Sawing with Carbide Tipped Blades

The safe and proper use of our products is very important to us and it is the end user's responsibility to follow all safety practices. One important aspect of safe saw operation is the saw blade speed. OSHA guidelines state the maximum safe cutting speed for wood is 15,000 surface feet per minute (SFM). For products other than wood, the maximum safe speed is lower. Optimum cutting speeds vary, but are typically between 50% and 75% of the maximum speed. Your experience will determine the speed which provides acceptable results. NEVER EXCEED THE MAXIMUM SAFE SAW SPEED.

Clamping the material securely at the point of cutting is required for good results. Sharpen the saw when indications of dulling appear which affect the finish. Please contact us with any questions.

A safety guide can be downloaded at www.everlastsaw.com.

Diameter (in)	Maximum RPM
7.25	7500
8	7000
10	5400
12	4500
14	3900
16	3400
18	3000
20	2700
22	2500
24	2250
26	2100

Cutting Speeds for Various Materials

All materials have an optimal cutting speed which is typically stated in Surface Feet Per Minute (SFM).

$$\text{SFM} = \text{Cutting Tool Diameter (inches)} \times \text{RPM} \times 0.262$$

The performance of all cutting tools, including Everlast saws, will be affected by:

- The type of machine being used
- Rigidity of the machine
- Cutting tool sharpness (dullness)
- Material feed type (manual or automatic)
- Secure clamping of material on both sides of the cutting tool
- Material being cut in single layer or stack cut

Consult with Everlast to help select the optimum saw for your cutting application.

Material	Cutting Speeds (SFM)
Alumimum – Soft / Medium Hard	18,000
Alumimum – Hard and/or Anodized	12,000
Brass – less than 150 Brinell	10,000
Bronze – less than 150 Brinell	12,000
Copper	10,000
Lead	14,000
Magnesium	15,000
Plastics	6,000 to 10,000

Before cutting any material, consult the manufacturer as they can provide the optimal cutting speed.

SAW BLADE DESIGN ELEMENTS

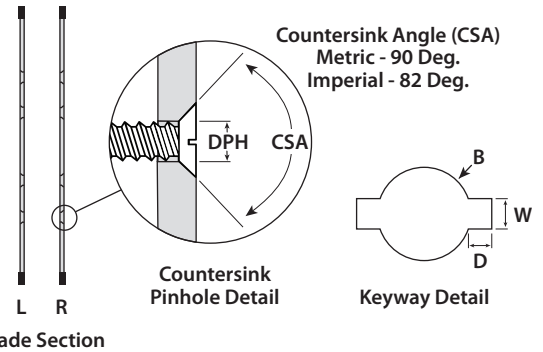
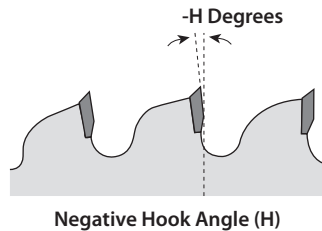
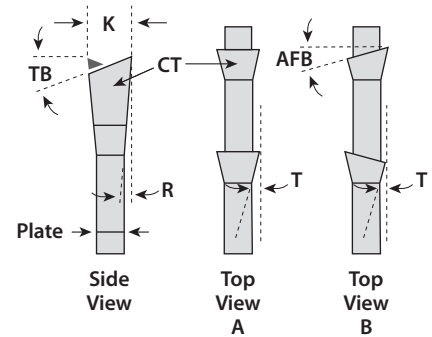
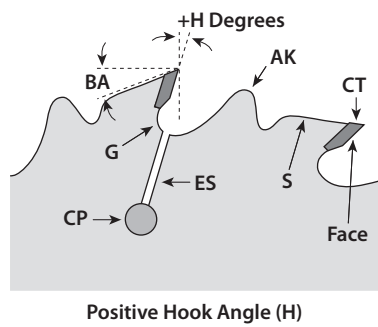
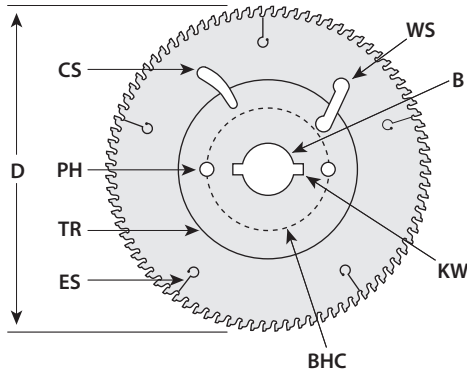

Alternate Face Bevel (AFB) – Provide angle bevel on tooth face for ATB grind only.

Anti-Kickback Shoulder (AK) – Shoulder design which prevents kickback during cutting.

Back Angle (BA) – Clearance angle at top of blade. Affects shoulder strength and changes with blade type.

Bolt Hole Circle (BHC) – The common diameter for all pinholes on the saw blade.

Bore (B) – Saw blades are mounted to the cutting machine. Also known as the arbor hole.

Carbide Tip (CT) – Available in a wide-variety of grades for cutting various materials. Tips are brazed to the plate and can be re-sharpened.

Cooling Slot (CS) – Special design slots cut into the saw plate in order to promote cooling during cutting.

Copper Plug (CP) – Press-fit into saw plate to assist with vibration and noise reduction.

Diameter (D) – Distance from tip to tip across the blade.

Expansion Slot (ES) – Reduces vibration and noise. Allows expansion and contraction caused by heating.

Face (F) – Flat plane of each tip that is parallel with hook angle. The face is typically re-ground each time the blade is sharpened to provide a “new” cutting edge with the tip sides and top.

Gullet (G) – Area between shoulder and next tip into which material being cut gathers and is ejected.

Keyway (KW) – Mounting feature required by some cutting machines. Provide Width (W) and Depth (D).

Hook Angle (H) – Angle formed between tooth face and a radial line from center of bore. Forward leaning = Positive and Backward leaning = Negative.

Kerf (K) – Tip width measured at widest point.

Pin Hole (PH) – Mounting feature required by some cutting machines. Specify quantity, diameter (PHD), BHC and countersink information (if required). Example 2/10/60.

Plate (P) – Saw body to which carbide tips are brazed and ground to create a finished saw blade.

Radial Side Clearance (R or T-B) – Relief created by precision grinding to prevent side of tip from contacting material being cut and causing melting or burning.

Shoulder (S) – The portion of the saw plate to which carbide tip is brazed. Varies with blade design and material being cut.

Side – Both sides of each tip have a compound grind to provide adequate clearance for the material being cut.

Tangential Clearance (T or F-B) – Relief from front of tip to back of tip to provide clearance during cutting to prevent melting or burning.

Tension Ring (TR) – Ring created during the tensioning process to assist with keeping plate straight and flat during the cutting process.

Top Bevel Angle (TB) – Created by precision grinding the top of each tip. A steeper (larger) angle provides a sharper tooth, but one which becomes dull more quickly.

STANDARD TOP GRINDS



Blade Type: Astra Wood, Biscuit Cutter (LAM), General Purpose (GP), Radial Overarm (RO), Std Purpose (SP), Special Purpose (SPE), Thin Kerf (TK), Thin Rim (TR)

Alternate Top Bevel - ATB

Each tooth has top bevel typically between 10 and 20 degrees. Two (2) teeth are required to provide a full kerf cut. Provides low cutting pressures which reduce material tearing during the cutting process and provides a fine cutting finish. Best performance cross cutting.



Blade Type: Double Face Laminate (DFL), Panel Saws (metric sizes)

High Alternate Top Bevel - Hi ATB

Identical configuration to ATB, but each tooth has top bevel of 30 degrees or more. The greater angle can cause faster wearing/dulling. Combine with Micro-5 carbide to increase time between sharpenings. Ideal for cutting of laminated materials. Provides a fine cutting finish with proper sharpening. An Alternate Face Bevel (AFB) can be added to this design upon request.



Blade Type: Astra Miter (ASMT), Combination (CBS), Double Face Veneer (DFV), Miter (MT)

Alternate with Raker - AR

Similar configuration to ATB, but every fifth (5th) tooth is a raker which assist is reducing cutting pressure and material tearing during cutting. Can be used for rip cutting and cross cutting in a variety of hard woods, soft woods, plywood and chipboard. This tooth configuration can be produced in a 2+1 or 3+1 design upon request.



Blade Type: Heavy Duty (HD), Groovers (GRO), Scoring Saws (Conic & Split), Slotting Cutters (EGS)

Straight Top Grind - STR

Each tooth will cut full kerf making this design very effective for removing material however high cutting pressures are present. Typically used for rip cutting hardwood and softwood.



Blade Type: Astra Non Ferrous (ASNF), Astra Panel Saws, Glue Line Rip (GL), General Purpose (GP), Non Ferrous (NF), Std Purpose (SP), Special Purpose (SPE), Thin Kerf (TK), Thin Rim (TR)

Triple Chip Grind - TCG

This design uses a trapezoidal tooth with 45 deg bevel on each side which performs the cutting work followed by a lower, STR tooth (raker) tooth for clean-out. Strong tooth design for cutting harder materials such as man-made laminates (single sided) and non-ferrous materials. Can be used for rip cutting and cross cutting.



Blade Type: Counter Top (CT), Double Face Laminate (DFL), Plex Cut (PC), Solid Surface (DFLC)

Modified Triple Chip Grind - TC45

This design starts with TCG configuration, but the STR (raker) tooth has small 45 degree chamfer. The addition of this chamfer, along with special clearances, provides the best possible finish on double face laminate and solid surface materials. This design provides good service life with excellent surface finish on table saws and radial arm saws.



Blade Type: Double Cut Off (DCO)

4 + 1

Four (4) ATB teeth are followed by one (1) ATB with bevel in opposite direction. Used for Double Cut Off machines where Left Hand (LH) and Right Hand (RH) blades are used to size materials during the cutting process. Pay special attention when ordering these blades due to the RH and LH configurations.

GLUE LINE RIP SAWS – GL HEAVY DUTY RIP SAWS – HD

**TCG
STR**

GL-series saws utilize a heavy plate and TCG grind to provide a smooth cut for all glue line applications on either straight or shadow line rip saws. For best results, use GL saws for rip cutting only. HD-series saws are specially designed for fast cutting on both manual and power feed ripping operations. Design features include large gullets, heavier plates and use of the proper clearances designed for this type of heavy duty cutting in both hard or soft woods. Modifications such as special grinds, bores, keyways and pinholes can be provided on all GL and HD items.

	Grind & Saw No.			Diameter	Teeth	Bore	Hook	Plate		Kerf	
	ATB	TCG	STR					Inch	mm	Inch	mm
	HD724A	GL724	HD724	7.25"	24	5/8"	20°	0.072	1.8	0.112	2.8
	HD824A		HD824	8"	24	5/8"	15°	0.087	2.2	0.125	3.2
	HD924A		HD924	9"	24	5/8"	15°	0.087	2.2	0.134	3.4
	HD1024A	GL1024	HD1024	10"	24	5/8"	20°	0.095	2.4	0.145	3.7
(1)	HD102470A		HD102470	10"	24	70mm	20°	0.095	2.4	0.145	3.7
	HD1030A	GL1030	HD1030	10"	30	5/8"	20°	0.095	2.4	0.145	3.7
(1)		GL103070-24		10"	30	70mm	20°	0.095	2.4	0.145	3.7
	HD1040A	GL1040	HD1040	10"	40	5/8"	15°	0.087	2.2	0.125	3.2
(2)	HD30024A		HD30024	300mm	24	70mm	20°	0.087	2.2	0.125	3.2
	HD1224-22A		HD1224-22	12"	24	1"	20°	0.087	2.2	0.125	3.2
(1)	HD122470-22A		HD122470-22	12"	24	70mm	20°	0.087	2.2	0.125	3.2
	HD1224A		HD1224	12"	24	1"	20°	0.110	2.8	0.160	4.1
(1)	HD122470-28A		HD122470-28	12"	24	70mm	20°	0.110	2.8	0.160	4.1
	HD1230A	GL1230	HD1230	12"	30	1"	20°	0.110	2.8	0.160	4.1
(1)	HD123070A		HD123070	12"	30	70mm	20°	0.110	2.8	0.160	4.1
	HD12361A	GL12361	HD12361	12"	36	1"	20°	0.118	3.0	0.160	4.1
(1)		GL123670		12"	36	70mm	20°	0.118	3.0	0.160	4.1
(3)	HD1236A	GL1236	HD1236	12"	36	3-1/8"	20°	0.118	3.0	0.160	4.1
(1)	HD123670A		HD123670	12"	36	70mm	20°	0.118	3.0	0.160	4.1
	HD1424A		HD1424	14"	24	1"	20°	0.118	3.0	0.170	4.3
(1)	HD142470A		HD142470	14"	24	70mm	20°	0.118	3.0	0.170	4.3
	HD1436A	GL14361	HD1436	14"	36	1"	20°	0.118	3.0	0.170	4.3
(4)		GL1436D		14"	36	2"	20°	0.118	3.0	0.170	4.3
(1)	HD143670A		HD143670	14"	36	70mm	20°	0.118	3.0	0.170	4.3
	HD1636A	GL1636	HD1636	16"	36	1"	20°	0.118	3.0	0.170	4.3
(4)		GL1636D	HD1636D	16"	36	2"	20°	0.118	3.0	0.170	4.3
	HD1840A		HD1840	18"	40	1"	15°	0.134	3.4	0.184	4.7
(4)		GL1840D		18"	40	2"	15°	0.134	3.4	0.184	4.7
	HD2040A		HD2040	20"	40	1"	10°	0.148	3.8	0.190	4.8

- (1) 2 Keyways - 20 mm W x 5 mm D
- (2) 2 Keyways - 20 mm W x 10 mm D with Anti Kick Back
- (3) For Mereen-Johnson
- (4) For Diehl saw with one (1) each 9/16" pinhole on 5.0" BHC

Special grinds, bores, pinholes and keyways can be provided on all of the above items. Contact Everlast if a Saw Number is not listed.

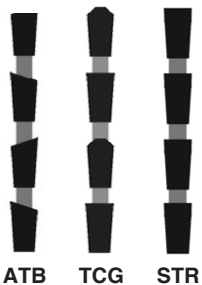

Inch	Metric	Inch	Metric	Inch	Metric	Inch	Metric	Inch	Metric	Inch	Metric
0.625	15.875	1.575	40	6.299	160	10.236	260	16	406	22.441	570
0.750	19	1.969	50	7.25	184	11.811	300	16.535	420	22.5	572
0.787	20	2.362	60	8	203	12	305	17.717	450	24	610
0.866	22	2.559	65	8.268	210	12.992	330	18	457	25.591	650
1.181	30	2.756	70	8.5	216	13.780	350	19.685	500	26	660
1.250	31.750	2.953	75	9	229	14	356	20	508	28	711
1.260	32	3.150	80	9.843	250	14.961	380	21.654	550	30	762
1.500	38.100	3.937	100	10	254	15.748	400	22	559	32	813

ASTRA WOOD – AGP

Alternate Top Bevel

Everlast offers an alternative to the Forrest Woodworker IITM*Blade. Exceptional cut on rip and crosscut. Rated: Excellent & Very good in Fine Woodworking Magazine.**

Saw No.	Diameter	Teeth	Bore	Grind	Hook	Plate		Kerf	
						Inch	mm	Inch	mm
(1) AGP1040	10"	40	5/8"	ATB	15°	0.087	2.2	0.115	2.9
AGP1048	10"	48	5/8"	ATB	20°	0.087	2.2	0.125	3.2
AGP1060	10"	60	5/8"	ATB	-2°	0.080	2.0	0.110	2.8
AGP124058	12"	40	5/8"	ATB	15°	0.095	2.4	0.115	2.9
AGP1240	12"	40	1"	ATB	15°	0.095	2.4	0.115	2.9
AGP1248	12"	48	1"	ATB	20°	0.110	2.8	0.148	3.8
AGP1260	12"	60	1"	ATB	15°	0.095	2.4	0.115	2.9



(1) Article: "10-in. Combination Table Saw Blades" All saws available with special bores & pinholes

*Trademark Forrest Mfg. Co.

GENERAL PURPOSE CUT-OFF SAWS – GP

Alternate Top Bevel or Triple Chip

Designed for all around general purpose cutting in solid woods, plywood, masonite, chip core, and laminated formica (single sided). Triple chip grind recommended for cutting all types of abrasive materials such as chip board or high pressure laminates.

	ATB	TCG	Dia.	Teeth	Bore	Hook	Plate		Kerf	
							Inch	mm	Inch	mm
	GP724A	GP724T	7.25"	24	5/8"	20°	0.072	1.8	0.112	2.8
	GP740A	GP740T	7.25"	40	5/8"	10°	0.072	1.8	0.112	2.8
	GP840A	GP840T	8"	40	5/8"	15°	0.087	2.2	0.125	3.2
New	GP81236A	GP81236T	8.5"	36	5/8"	15°	0.066	1.7	0.096	2.5
	GP940A	GP940T	9"	40	5/8"	15°	0.087	2.2	0.125	3.2
	GP1040A	GP1040T	10"	40	5/8"	15°	0.087	2.2	0.125	3.2
	GP1048A	GP1048T	10"	40	5/8"	20°	0.087	2.2	0.125	3.2
(1)	MGP1024A	NA	10.25"	24	5/8"	10°	0.070	1.8	0.095	2.4
(1)	MGP1036A	NA	10.25"	36	5/8"	10°	0.070	1.8	0.095	2.4
	GP124058A	GP124058T	12"	40	5/8"	15°	0.095	2.4	0.134	3.4
	GP1240A	GP1240T	12"	40	1"	15°	0.095	2.4	0.134	3.4
	GP1248A	GP1248T	12"	48	1"	20°	0.110	2.8	0.160	4.1
	GP1440A	GP1440T	14"	40	1"	15°	0.118	3.0	0.165	4.2
	GP1640A	GP1640T	16"	40	1"	15°	0.118	3.0	0.165	4.2
	GP1840A	GP1840T	18"	40	1"	15°	0.134	3.4	0.190	4.8
	GP2040A	GP2040T	20"	40	1"	10°	0.148	3.4	0.190	4.8

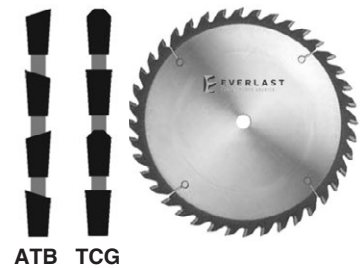

(1) Bore has diamond knock-out. Designed for use with hand-held saws such as Big Foot brand.

COMBINATION SAWS – CBS

Alternate with Raker

An excellent all around saw ideally suited for the small woodworking or cabinet shops where one saw is used for all different types of cutting. It can be used for ripping or cross cutting in solid woods, particle board, plywood or laminated panels.

Saw No.	Diameter	Teeth	Bore	Grind	Hook	Plate		Kerf	
						Inch	mm	Inch	mm
CBS740	7.25"	40	5/8"	AR	15°	0.087	2.2	0.125	3.2
CBS840	8"	40	5/8"	AR	15°	0.087	2.2	0.125	3.2
CBS940	9"	40	5/8"	AR	15°	0.087	2.2	0.125	3.2
CBS1050	10"	50	5/8"	AR	15°	0.087	2.2	0.125	3.2
CBS1260	12"	60	1"	AR	15°	0.110	2.8	0.153	3.9
CBS1470	14"	70	1"	AR	15°	0.110	2.8	0.153	3.9
CBS1680	16"	80	1"	AR	15°	0.118	3.0	0.165	4.2

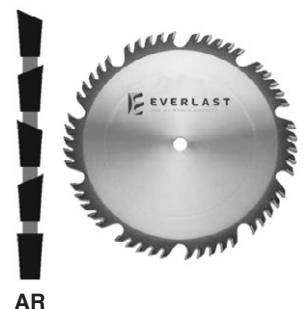

Custom saws, grinds, bore sizes and pinholes available upon request.

STANDARD PURPOSE CUT-OFF SAWS – SP
SPECIAL PURPOSE CUT-OFF SAWS – SPE

Alternate Top Bevel
or Triple Chip

Ideal for table saw use to provide fine finishing cuts in plywood, veneered panels, single-side laminated panels, masonite (coated or uncoated) along with crosscutting in hard or soft woods. Use blades with more teeth when sawing thinner materials to provide quality cut and finish. Triple chip grind are best used for cutting all types of abrasive materials such as chip board or dense laminates. All blades feature expansion slots with copper plugs to reduce noise, dissipate heat and attenuate vibration during the cutting process.

	Saw Number		Diameter	Teeth	Bore	Hook	Plate		Kerf		Pinholes
	ATB	TCG					Inch	mm	Inch	mm	
	SP71456A	SP71456T	7-1/4"	56	5/8"	10°	0.072	1.8	0.102	2.6	
	SP860A	SP860T	8"	60	5/8"	10°	0.087	2.2	0.125	3.2	
	SP960A	SP960T	9"	60	5/8"	10°	0.087	2.2	0.125	3.2	
	LSP1060A	LSP1060T	10"	60	5/8"	10°	0.087	2.2	0.125	3.2	
New	† SP22064A5	SP22064T5	220mm	64	TCG	5°	0.087	2.2	0.125	3.2	2/7/42
	† SPE25080A5	SPE25080T5	250mm	80	30mm	15°	0.087	2.2	0.125	3.2	2/7/42
	SPE1080A	SPE1080T	10"	80	5/8"	5°	0.087	2.2	0.125	3.2	
	† SP30060A5	SP30060T5	300mm	60	30mm	10°	0.095	2.4	0.134	3.4	2/10/60
	† SPE30072A5	SPE30072T5	300mm	72	30mm	5°	0.087	2.2	0.125	3.2	2/7/42, 2/10/60
	† SPE30010A5	SPE30010T5	300mm	100	30mm	5°	0.080	2.2	0.134	3.4	2/7/42, 2/10/60
	SP1260A	SP1260T	12"	60	1"	10°	0.095	2.4	0.135	3.4	
	SPE1280A	SPE1280T	12"	80	1"	5°	0.095	2.4	0.135	3.4	
	SPE1210A	SPE1210T	12"	100	1"	5°	0.095	2.4	0.135	3.4	
	SP1460A	SP1460T	14"	60	1"	10°	0.109	2.8	0.150	3.8	
	SPE1480A	SPE1480T	14"	80	1"	10°	0.109	2.8	0.150	3.8	
	SPE1410A	SPE1410T	14"	100	1"	5°	0.109	2.8	0.150	3.8	
	SP1660A	SP1660T	16"	60	1"	10°	0.109	2.8	0.150	3.8	
	SPE1680A	SPE1680T	16"	80	1"	10°	0.109	2.8	0.150	3.8	
	SPE1610A	SPE1610T	16"	100	1"	5°	0.118	3.0	0.160	4.1	
	SPE1620A	SPE1620T	16"	120	1"	5°	0.118	3.0	0.160	4.1	
	SP1860A	SP1860T	18"	60	1"	10°	0.134	3.4	0.175	4.4	
	SPE1880A	SPE1880T	18"	80	1"	10°	0.134	3.4	0.175	4.4	
	SPE1810A	SPE1810T	18"	100	1"	10°	0.134	3.4	0.175	4.4	
	SPE1820A	SPE1820T	18"	120	1"	5°	0.134	3.4	0.175	4.4	
	† SPE500144A	SPE500144T	500mm	144	30mm	10°	0.125	3.2	0.175	4.4	
	SP2060A	SP2060T	20"	60	1"	10°	0.134	3.4	0.175	4.4	
	SPE2080A	SPE2080T	20"	80	1"	10°	0.134	3.4	0.175	4.4	
	SPE2010A	SPE2010T	20"	100	1"	10°	0.134	3.4	0.175	4.4	
	SPE2010A-38	SPE2010T-38	20"	100	1"	10°	0.148	3.8	0.190	4.8	
	SPE2020A	SPE2020T	20"	120	1"	10°	0.134	3.4	0.175	4.4	
	SP2260A	SP2260T	22"	60	1"	10°	0.148	3.8	0.190	4.8	
	SPE2280A	SPE2280T	22"	80	1"	10°	0.148	3.8	0.190	4.8	
	SPE2210A	SPE2210T	22"	100	1"	10°	0.148	3.8	0.190	4.8	
	SPE2220A	SPE2220T	22"	120	1"	10°	0.148	3.8	0.190	4.8	
	SP2460A	SP2460T	24"	60	1"	5°	0.148	3.8	0.190	4.8	
	SPE2480A	SPE2480T	24"	80	1"	5°	0.148	3.8	0.190	4.8	
	SPE2410A	SPE2410T	24"	100	1"	5°	0.148	3.8	0.190	4.8	

† MICRO-5 extra hard tips provide 3 to 5 times longer service than standard carbide.



Inch-Metric Conversion Table for Common Saw Bores and Diameters

Inch	Metric	Inch	Metric	Inch	Metric	Inch	Metric	Inch	Metric	Inch	Metric
0.625	15.875	1.575	40	6.299	160	10.236	260	16	406	22.441	570
0.750	19	1.969	50	7.25	184	11.811	300	16.535	420	22.5	572
0.787	20	2.362	60	8	203	12	305	17.717	450	24	610
0.866	22	2.559	65	8.268	210	12.992	330	18	457	25.591	650
1.181	30	2.756	70	8.5	216	13.780	350	19.685	500	26	660
1.250	31.750	2.953	75	9	229	14	356	20	508	28	711
1.260	32	3.150	80	9.843	250	14.961	380	21.654	550	30	762
1.500	38.100	3.937	100	10	254	15.748	400	22	559	32	813

PLEX-CUT SAWS – PC, PLJ, PLN

TC45

Special tooth design for cutting plastics such as nylon, acrylic, plexiglass, lucite, ABS, lexan, and PVC pipe where melting is a problem. Good for material thickness up to 3/8 inch. Contact Everlast for cutting materials in excess of 3/8". Special design available for vinyl extrusion cutting.

	Saw No.	Diameter	Teeth	Bore	Grind	Hook	Plate		Kerf	
							Inch	mm	Inch	mm
	PC860	8"	60	5/8"	TC45	5°	0.072	1.8	0.106	2.7
	PC960	9"	60	5/8"	TC45	-5°	0.087	2.2	0.115	2.9
New	PC1012	10"	12	5/8"	TC45	10°	0.095	2.4	0.145	3.7
	PC1024	10"	24	5/8"	TC45	20°	0.095	2.4	0.145	3.7
	PC1080	10"	80	5/8"	TC45	5°	0.072	1.8	0.110	2.8
New	PC1080V	10"	80	5/8"	TC45	5°	0.072	1.8	0.106	2.7
	PC1240	12"	40	1"	TC45	15°	0.095	2.4	0.134	3.4
New	PC1260	12"	60	1"	TC45	10°	0.095	2.4	0.134	3.4
	PC1280	12"	80	1"	TC45	5°	0.087	2.2	0.125	3.0
(1)	PC121058V	12"	100	5/8"	TC45	-5°	0.098	2.5	0.128	3.3
New	PC1480N	14"	80	1"	TC45	-2°	0.110	2.8	0.150	3.7
	PC1410	14"	100	1"	TC45	5°	0.110	2.8	0.150	3.7
(1)	PC141058V	14"	100	5/8"	TC45	-2°	0.118	3.0	0.150	3.7
(1)	PC1410V	14"	100	1"	TC45	5°	0.110	2.8	0.150	3.7
(2)	PLJ141005AF	14"	100	1"	AR/AFB	20°	0.102	2.6	0.130	3.3
New	PC1420	14"	120	1"	TC45	-2°	0.118	3.0	0.148	3.8
	PLN16457	16"	45	1"	AR 2+1	20°	0.110	2.8	0.155	3.8
	PC1660	16"	60	1"	TC45	10°	0.110	2.8	0.148	3.8
	PC1680	16"	80	1"	TC45	10°	0.110	2.8	0.148	3.8
New	PC1610	16"	100	1"	TC45	5°	0.118	2.8	0.148	3.8
	PLJ161004	16"	100	1"	TC45	20°	0.102	2.6	0.134	3.4
(2)	PLJ161005AF	16"	100	1"	AR/AFB	20°	0.102	2.6	0.125	3.2
New	PC1620	16"	120	1"	TC45	5°	0.118	2.8	0.160	4.1
	PC1620N	16"	120	1"	TC45	-2°	0.118	2.8	0.160	4.1
	PC1860	18"	60	1"	TC45	10°	0.134	3.4	0.175	4.4
	PC1880	18"	80	1"	TC45	10°	0.134	3.4	0.175	4.4
	PC1810	18"	100	1"	TC45	10°	0.134	3.4	0.175	4.4
	PLJ181004	18"	100	1"	TC45	20°	0.102	2.6	0.142	3.6
	PLJ181204	18"	120	1"	TC45	20°	0.102	2.6	0.142	3.6
New	(2) PLJ181205AF	18"	120	1"	AR/AFB	20°	0.102	2.6	0.142	3.6
	PLN20547	20"	54	1"	AR	20°	0.134	3.4	0.185	4.7
	PLJ201004	20"	100	1"	TC45	20°	0.102	2.6	0.142	3.6
	PLJ201204	20"	120	1"	TC45	20°	0.102	2.6	0.142	3.6



TC45

Call Everlast for other plastic cutting saw configurations not shown.

1. Designed for cutting vinyl extrusions

2. Saws have 5 degree alternate face bevel

DOUBLE CUT-OFF & TRIM SAWS – DCO

4 & 1 Grind

Extra plate thickness gives these saws extreme stability when used on Double End or Panel Sizing machines, resulting in a splinter free finish on either sizing or angular cuts.

Saw No.	Diameter	Teeth	Bore	Grind	Hook	Plate		Kerf	
						Inch	mm	Inch	mm
DCO1080LH	10"	80	5/8"	LH	15°	0.087	2.2	0.130	3.3
DCO1080RH	10"	80	5/8"	RH	15°	0.087	2.2	0.130	3.3
DCO1280LH	12"	80	1"	LH	5°	0.118	3.0	0.165	4.2
DCO1280RH	12"	80	1"	RH	5°	0.118	3.0	0.165	4.2
DCO1210LH	12"	100	1"	LH	15°	0.095	2.4	0.138	3.5
DCO1210RH	12"	100	1"	RH	15°	0.095	2.4	0.138	3.5
DCO1410LH	14"	100	1"	LH	5°	0.134	3.4	0.180	4.6
DCO1410RH	14"	100	1"	RH	5°	0.134	3.4	0.180	4.6
DCO1610LH	16"	100	1"	LH	10°	0.134	3.4	0.180	4.6
DCO1610RH	16"	100	1"	RH	10°	0.134	3.4	0.180	4.6

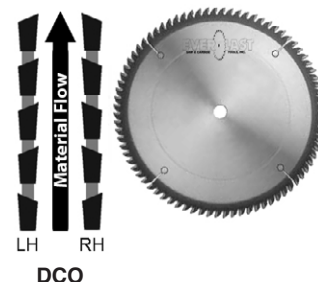

DCO

Other groupings such as 2+1, 3+1 up to 9+1 available when number of teeth allow. Contact Everlast with your specific needs.

Custom saws, grinds, bore sizes and pinholes available upon request.

EVERLAST

THIN RIM SAWS – TR

Alternate Top Bevel or Triple Chip

The perfect saw to use where there is a need for a minimum of stock removal per cut, as in the cutting of plastic or veneer strips for edge banding. Maximum depth of cut on Thin Rim blade is 1-3/4 inches.



Saw Number		Diameter	Teeth	Bore	Hook	Plate		Thin Rim Plate		Kerf	
ATB	TCG					Inch	mm	Inch	mm	Inch	mm
TR860A	TR860T	8"	60	5/8"	10°	0.087	2.2	0.056	1.4	0.087	2.2
TR1080A	TR1080T	10"	80	5/8"	5°	0.087	2.2	0.056	1.4	0.087	2.2
TR1280A	TR1280T	12"	80	1"	5°	0.095	2.4	0.062	1.6	0.091	2.3
TR1210A	TR1210T	12"	100	1"	5°	0.095	2.4	0.062	1.6	0.091	2.3

Alternate design with thin saw plate and thick support hubs on both sides available. Contact Everlast with your specific needs.

THIN KERF SAWS – TK

Alternate Top Bevel or Triple Chip

Thin kerf blades require less power for cutting and provide a minimum of stock waste. Triple chip grind recommended for cutting all types of abrasive materials.



Saw Number		Diameter	Teeth	Bore	Hook	Plate		Kerf	
ATB	TCG					Inch	mm	Inch	mm
TK724A	TK724T	7.25"	24	5/8"	20°	0.072	1.8	0.102	2.6
TK740A	TK740T	7.25"	40	5/8"	10°	0.072	1.8	0.102	2.6
TK756A	TK756T	7.25"	40	5/8"	10°	0.072	1.8	0.102	2.6
TK860A	TK860T	8"	60	5/8"	5°	0.072	1.8	0.102	2.6
TK81260AN	TK81260TN	8.5"	60	5/8"	-5°	0.072	1.8	0.102	2.6
TK1024A	TK1024T	10"	24	5/8"	20°	0.072	1.8	0.102	2.6
TK1040A	TK1040T	10"	40	5/8"	15°	0.072	1.8	0.102	2.6
TK1048A-20	TK1048T-20	10"	48	5/8"	20°	0.050	1.3	0.080	2.0
New TK1048A-24	TK1048T-24	10"	48	5/8"	20°	0.063	1.6	0.094	2.4
TK1060A	TK1060T	10"	60	5/8"	10°	0.072	1.8	0.102	2.6
TK1080A	TK1080T	10"	80	5/8"	5°	0.072	1.8	0.102	2.6
TK1080AN	TK1080TN	10"	80	5/8"	0°	0.072	1.8	0.102	2.6
TK1010AN	TK1010TN	10"	100	5/8"	-5°	0.072	1.8	0.098	2.5
TK1260AN	TK1260TN	12"	60	1"	-2°	0.080	2.0	0.110	2.8
TK1280A	TK1280T	12"	80	1"	5°	0.087	2.2	0.115	2.9
TK1280AN	TK1280TN	12"	80	1"	-2°	0.080	2.0	0.110	2.8
TK1210A	TK1210T	12"	100	1"	5°	0.095	2.4	0.115	2.9
TK1210AN	TK1210TN	12"	100	1"	-2°	0.080	2.0	0.110	2.8
New TK35072T1	TK35072A1	350mm	72	1"	13°	0.098	2.5	0.138	3.5
TK35072T	TK35072A	350mm	72	30mm	13°	0.098	2.5	0.138	3.5
TK1510AN	TK1510TN	15"	100	1"	-2°	0.085	2.2	0.115	2.9

AR grinds available upon request.

ASTRA SERIES MITRE SAWS (Wood and Non-Ferrous) – ASMT/ASN F

For the smoothest cutting of wood or aluminum mouldings. Extra stiff plates and special clearances provide extremely accurate cuts on double mitre machines such as Pistorius, Sampson, CTD, etc. Extra hard MICRO -5 tips used.

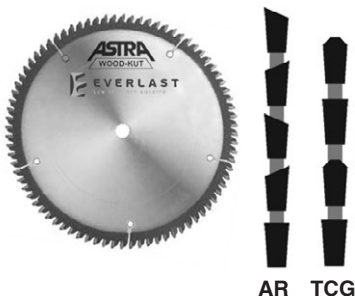

Saw No.	Diameter	Teeth	Bore	Grind	Hook	Plate		Kerf	
						Inch	mm	Inch	mm
ASMT128058	12"	80	5/8"	AR	-3°	0.095	2.4	0.115	2.9
ASN F128058	12"	80	5/8"	TCG	-3°	0.095	2.4	0.115	2.9

MICRO-5 extra hard tips provide 3 to 5 times longer service than standard carbide.

RADIAL OVERARM SAWS – RO

Alternate Top Bevel

	Saw No.	Diameter	Teeth	Bore	Grind	Hook	Plate		Kerf	
							Inch	mm	Inch	mm
New	RO860	8"	60	5/8"	ATB	-5°	0.087	2.2	0.115	2.9
	RO81260	8.5"	60	5/8"	ATB	-5°	0.072	1.8	0.102	2.6
New	RO960	9"	60	5/8"	ATB	-5°	0.087	2.2	0.115	2.9
	RO1024	10"	24	5/8"	ATB	-2°	0.095	2.4	0.134	3.4
New	RO1040	10"	40	5/8"	ATB	-2°	0.087	2.2	0.125	3.2
	RO1060	10"	60	5/8"	ATB	-2°	0.087	2.2	0.125	3.2
New	RO1080	10"	80	5/8"	ATB	-5°	0.087	2.2	0.115	2.9
	RO1230	12"	30	5/8"	ATB	-2°	0.095	2.4	0.134	3.4
	RO12301	12"	30	1"	ATB	-2°	0.095	2.4	0.134	3.4
	RO1240	12"	40	5/8"	ATB	-2°	0.095	2.4	0.134	3.4
	RO12401	12"	40	1"	ATB	-2°	0.095	2.4	0.134	3.4
	RO1260	12"	60	5/8"	ATB	-2°	0.095	2.4	0.134	3.4
	RO12601	12"	60	1"	ATB	-2°	0.095	2.4	0.134	3.4
	RO1280	12"	80	1"	ATB	-2°	0.095	2.4	0.125	3.2
	RO128058	12"	80	5/8"	ATB	-2°	0.095	2.4	0.125	3.2
New	RO1210	12"	100	1"	ATB	-5°	0.098	2.5	0.128	3.3
	RO121058	12"	100	5/8"	ATB	-5°	0.098	2.5	0.128	3.3
	RO1440	14"	40	1"	ATB	-2°	0.118	3.0	0.165	4.2
	RO1460	14"	60	1"	ATB	-2°	0.118	3.0	0.148	3.8
	RO1480	14"	80	1"	ATB	-2°	0.110	2.8	0.148	3.8
	RO1410	14"	100	1"	ATB	-2°	0.118	3.0	0.148	3.8
	RO1560	15"	60	1"	ATB	-2°	0.095	2.4	0.118	3.0
	RO1640	16"	40	1"	ATB	-2°	0.118	3.0	0.165	4.2
	RO1660	16"	60	1"	ATB	-2°	0.118	3.0	0.165	4.2
	RO1680	16"	80	1"	ATB	-2°	0.118	3.0	0.165	4.2
	RO1610	16"	100	1"	ATB	-2°	0.118	3.0	0.165	4.2
	RO1860	18"	60	1"	ATB	-2°	0.134	3.4	0.180	4.6
	RO1880	18"	80	1"	ATB	-2°	0.134	3.4	0.180	4.6
	RO1810	18"	100	1"	ATB	-2°	0.134	3.4	0.180	4.6
	RO1820	18"	120	1"	ATB	-2°	0.134	3.4	0.180	4.6
	RO2060	20"	60	1"	ATB	0°	0.134	3.4	0.170	4.3
	RO22560	22.5"	60	1"	ATB	-5°	0.148	3.8	0.190	4.8
	RO22520	22.5"	120	1"	ATB	-5°	0.148	3.8	0.190	4.8

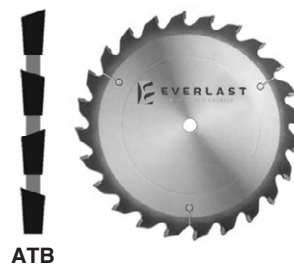

ATB

Heavy, stable saw body provides excellent cutting results on all types of radial saws. The negative tooth design reduces saw "grabbing" or self-feeding which can be an issue with overarm machine designs.

MITRE SAWS – MT

Alternate with Raker

	Saw No.	Diameter	Teeth	Bore	Grind	Hook	Plate		Kerf	
							Inch	mm	Inch	mm
	MT860	8"	60	5/8"	AR	-5°	0.087	2.2	0.115	2.9
	MT81260	8.5"	60	5/8"	ATB	-5°	0.072	1.8	0.102	2.6
	MT960	9"	60	5/8"	AR	-5°	0.087	2.2	0.115	2.9
New	† MT25080	250mm	80	30mm	TC45	-5°	0.087	2.2	0.115	2.9
	MT1060	10"	60	5/8"	AR	-2°	0.080	2.0	0.110	2.8
	MT1080	10"	80	5/8"	AR	-5°	0.087	2.2	0.115	2.9
	* MT1080M	10"	80	5/8"	AR	0°	0.072	1.8	0.102	2.6
New	TKMT1010	10"	100	5/8"	AR	-5°	0.072	1.8	0.098	2.5
	MT1010	10"	100	5/8"	AR	-5°	0.094	2.4	0.125	3.2
	MT27510	10.8"	100	32mm	AR	0°	0.095	2.4	0.120	3.0
New	MT12601	12"	60	1"	AR	-2°	0.095	2.4	0.125	3.2
	MT126058	12"	60	5/8"	AR	-2°	0.095	2.4	0.125	3.2
	* MT1260D	12"	60	1"	AR	-2°	0.080	2.0	0.110	2.8
	MT1280	12"	80	1"	AR	-2°	0.095	2.4	0.125	3.2
	* MT1280D	12"	80	1"	AR	-2°	0.080	2.0	0.110	2.8
	* TKMT1210	12"	100	1"	AR	-2°	0.080	2.0	0.110	2.8
	MT1210	12"	100	1"	AR	-5°	0.098	2.5	0.128	3.3
	MT121058	12"	100	5/8"	AR	-5°	0.098	2.5	0.128	3.3
	MT1220	12"	120	1"	AR	-2°	0.110	2.8	0.148	3.8
	MT122058	12"	120	5/8"	AR	-2°	0.110	2.8	0.148	3.8
	MT1490	14"	90	1"	AR	-2°	0.118	3.0	0.148	3.8
	MT1410	14"	100	1"	AR	-2°	0.118	3.0	0.148	3.8
	MT141058	14"	100	5/8"	AR	-2°	0.118	3.0	0.148	3.8
New	MT1420	14"	120	1"	AR	-2°	0.118	3.0	0.148	3.8
	MT142058	14"	120	5/8"	AR	-2°	0.118	3.0	0.148	3.8
	* MT1510D	15"	100	1"	AR	-2°	0.085	2.2	0.115	2.9
	MT1510	15"	100	1"	AR	-2°	0.125	3.2	0.155	4.0
New	MT40020	400mm	120	30mm	AR	-5°	0.118	3.0	0.148	3.8
	MT1610	16"	100	1"	AR	-2°	0.118	3.0	0.148	3.8
New	NF42010	420mm	100	30mm	AR	0°	0.134	3.4	0.165	4.2

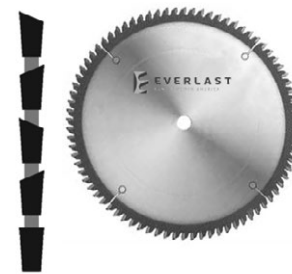

AR

Especially designed for cutting wood mouldings on all types of mitre machines and Rockwell type mitre box saws. Negative tooth design provides the least possible grabbing of material. All blades available with ATB or Hi-ATB tooth configuration.

* Thin kerf for Makita, Ryobi, Craftsman, Dewalt & Hitachi

† Pinholes: 2/7/42, 2/10/60

Custom saws, grinds, bore sizes and pinholes available upon request.

DOUBLE FACE LAMINATE SAWS – DFL

30 Degree ATB and TC45

The perfect saw for cutting double sided materials such as Melamine, Kortron & Veneer. Can be used on radial or table saws. Extra hard MICRO-5 tips last 3-5 times longer than normal carbide. The TC45 grind provides a stronger tooth for harder materials.



Hi ATB



TC45

Saw No.	Diameter	Teeth	Bore	Grind	Hook	Plate		Kerf		Pinholes
						Inch	mm	Inch	mm	
DFL860	8"	60	5/8"	TC45	-5°	0.087	2.2	0.115	2.9	
DFL86030	8"	60	5/8"	30° ATB	-5°	0.087	2.2	0.115	2.9	
† DFL2206430	220mm	64	30mm	30° ATB	-5°	0.087	2.2	0.115	2.9	2/7/42
New DFL960	9"	60	5/8"	TC45	-5°	0.087	2.2	0.115	2.9	
DFL96030	9"	60	5/8"	30° ATB	-5°	0.087	2.2	0.115	2.9	
† DFL25080	250mm	80	30mm	TC45	-5°	0.087	2.2	0.115	2.9	2/7/42, 2/10/60
† DFL2508030	250mm	80	30mm	30° ATB	-5°	0.087	2.2	0.115	2.9	2/7/42, 2/10/60
New DFL106030	10"	60	5/8"	30° ATB	-2°	0.080	2.0	0.110	2.8	
DFL1080	10"	80	5/8"	TC45	-5°	0.087	2.2	0.115	2.9	
DFL108030	10"	80	5/8"	30° ATB	-5°	0.087	2.2	0.115	2.9	
† DFL1080305	10"	80	5/8"	30° ATB	-5°	0.087	2.2	0.115	2.9	
(1) DFL128030	12"	80	5/8"	30° ATB	-5°	0.098	2.5	0.128	3.3	
DFL128030-01	12"	80	30mm	30° ATB	-5°	0.094	2.4	0.128	3.3	2/7/42, 2/9/46, 2/10/60
† DFL3001030	300mm	100	30mm	30° ATB	-5°	0.087	2.2	0.115	2.9	2/7/42, 2/10/60
(1) DFL1210	12"	100	1"	TC45	-5°	0.095	2.4	0.125	3.2	
(1) DFL121030	12"	100	1"	30° ATB	-5°	0.095	2.4	0.125	3.2	
† DFL1210305	12"	100	1"	30° ATB	-5°	0.095	2.4	0.125	3.2	
(1) DFL1410	14"	100	1"	TC45	-2°	0.118	3.0	0.148	3.8	
(1) DFL141030	14"	100	1"	30° ATB	-2°	0.118	3.0	0.148	3.8	
New (1) DFL142030	14"	120	1"	30° ATB	-2°	0.118	3.0	0.148	3.8	
DFL1620	16"	120	1"	TC45	-2°	0.118	3.0	0.148	3.8	
DFL162030	16"	120	1"	30° ATB	-2°	0.118	3.0	0.148	3.8	

† MICRO-5 extra hard tips provide 3 to 5 times longer service than standard carbide. (1) Available with 5/8" bore.

DOUBLE FACE VENEER SAWS – DFV

Alternate with Raker

A saw specifically recommended for the cutting of double sided veneered panels either with or against the grain. Will also give splinter free cuts in plywood. Also for the cutting of veneer or hardwood strips for edge banding.



AR



Saw No.	Diameter	Teeth	Bore	Grind	Hook	Plate		Kerf	
						Inch	mm	Inch	mm
DFV860	8"	60	5/8"	AR	-5°	0.087	2.2	0.115	2.9
DFV1080	10"	80	5/8"	AR	-5°	0.087	2.2	0.115	2.9
DFV1210	12"	100	1"	AR	-5°	0.095	2.4	0.125	3.2
DFV1410	14"	100	1"	AR	-2°	0.118	3.0	0.148	3.8
DFV1620	16"	120	1"	AR	-2°	0.118	3.0	0.148	3.8

STEEL-KUT (FOR FERROUS METAL) – JEP

"Steel-Kut" advantages: Long life compared to grinding discs, can be resharpened many times, excellent cut quality, no danger of sparks during cutting, cuts faster than grinding disc. "Steel-Kut" can be used for cutting the following materials: Steel bars, rebars, angle iron, steel channel, flat steel, aluminum bars, flat stock. "Steel-Kut" can be used on dry-cutting chop saw such as Jepson, provided the recommended RPM is not exceeded.



JEP



Saw No.	Diameter	Teeth	Bore	Grind	Hook	Plate		Kerf		Max. RPM
						Inch	mm	Inch	mm	
JEP1050	10"	50	5/8"	JEP	0°	0.072	1.8	0.087	2.2	1750
JEP1260	12"	60	1"	JEP	0°	0.072	1.8	0.087	2.2	1500
JEP1280	12"	80	1"	JEP	0°	0.072	1.8	0.087	2.2	1500
JEP1472	14"	72	1"	JEP	0°	0.072	1.8	0.087	2.2	1300
JEP1510	15"	100	1"	JEP	0°	0.072	1.8	0.087	2.2	1200

**NON-FERROUS
METAL CUTTING
NF**

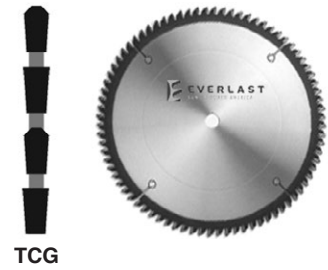

TCG

Designed for smooth, burr free cuts on all types of aluminum extrusions, thin wall tubing and thin gauge sheets with a wall thickness of 1/16 inch to 1/8 inch. These blades work particularly well on double mitre or portable mitre box machines. Please note that a lubricant should always be used during cutting and material should always be firmly secured while being cut.

Saw blades for vinyl window moulding can be supplied upon request.

*Thin kerf for Makita, Ryobi, Craftsman, Dewalt & Hitachi.

Pinholes
(1) 2/7/42, 2/10/60
(2) 2/9/55, 4/12/64

New

New

New

New

Saw No.	Diameter	Teeth	Bore	Hook	Plate		Kerf	
					Inch	mm	Inch	mm
NF740	7.25"	40	5/8"	-2°	0.080	2.0	0.110	2.8
NF860	8"	60	5/8"	-5°	0.087	2.2	0.115	2.9
NF81260	8.5"	60	5/8"	-5°	0.072	1.8	0.102	2.6
NF960	9"	60	5/8"	-5°	0.087	2.2	0.115	2.9
(1) NF25080	250mm	80	30mm	-5°	0.087	2.2	0.115	2.9
NF1060	10"	60	5/8"	-2°	0.087	2.2	0.115	2.9
* NF1060TK	10"	60	5/8"	-2°	0.080	2.0	0.110	2.8
NF1080	10"	80	5/8"	-5°	0.094	2.4	0.125	3.2
* NF1080M	10"	80	5/8"	0°	0.072	1.8	0.102	2.6
NF1010	10"	100	5/8"	-5°	0.094	2.4	0.125	3.2
TKNF1010	10"	100	5/8"	-5°	0.072	1.8	0.098	2.5
(1) NF27510	10.8"	100	32mm	0°	0.095	2.4	0.120	3.0
(1) NF30010	300mm	100	30mm	-5°	0.087	2.2	0.115	2.9
NF1240	12"	40	1"	-2°	0.095	2.4	0.125	3.2
NF1260	12"	60	5/8"	-2°	0.095	2.4	0.125	3.2
NF12601	12"	60	1"	-2°	0.095	2.4	0.125	3.2
NF1280	12"	80	1"	-2°	0.095	2.4	0.125	3.2
* NF1280D	12"	80	1"	0°	0.080	2.0	0.110	2.8
* TKNF1210	12"	100	1"	-2°	0.080	2.0	0.110	2.8
NF1210	12"	100	1"	-5°	0.098	2.5	0.128	3.3
NF121058	12"	100	5/8"	-5°	0.098	2.5	0.128	3.3
NF1220	12"	120	1"	-2°	0.110	2.8	0.148	3.8
NF122058	12"	120	5/8"	-2°	0.110	2.8	0.148	3.8
NF35072	350mm	72	1"	5°	0.102	2.6	0.134	3.4
NF35080	350mm	80	1"	5°	0.102	2.6	0.134	3.4
(2) NF35084	350mm	84	30mm	-5°	0.110	2.8	0.148	3.8
(2) NF35084-32	350mm	84	32mm	-5°	0.110	2.8	0.148	3.8
(2) NF35084-40	350mm	84	40mm	-5°	0.110	2.8	0.148	3.8
NF35008	350mm	108	1"	5°	0.102	2.6	0.134	3.4
NF35020	350mm	120	1"	5°	0.102	2.6	0.134	3.4
NF38010	380mm	100	30mm	0°	0.125	3.2	0.148	3.8
NF1460	14"	60	1"	-2°	0.110	2.8	0.148	3.8
NF1480	14"	80	1"	-2°	0.110	2.8	0.148	3.8
NF1490	14"	90	1"	-2°	0.118	3.0	0.148	3.8
NF1410	14"	100	1"	-2°	0.118	3.0	0.148	3.8
NF141058	14"	100	5/8"	-2°	0.118	3.0	0.148	3.8
NF1420	14"	120	1"	-2°	0.118	3.0	0.148	3.8
NF142058	14"	120	5/8"	-2°	0.118	3.0	0.148	3.8
* NF1510D	15"	100	1"	-2°	0.087	2.2	0.115	2.9
NF1510	15"	100	1"	-2°	0.125	3.2	0.155	4.0
NF40096	400mm	96	30mm	-2°	0.118	3.0	0.148	3.8
NF40020	400mm	120	1"	-2°	0.118	3.0	0.148	3.8
NF42010	420mm	100	30mm	0°	0.134	3.4	0.165	4.2
NF1660	16"	60	1"	-2°	0.118	3.0	0.148	3.8
NF1680	16"	80	1"	-2°	0.118	3.0	0.148	3.8
NF1610	16"	100	1"	-2°	0.118	3.0	0.148	3.8
NF1620	16"	120	1"	-2°	0.118	3.0	0.150	3.8
NF1860	18"	60	1"	-2°	0.134	3.4	0.165	4.2
NF1880	18"	80	1"	-2°	0.134	3.4	0.165	4.2
NF1810	18"	100	1"	-2°	0.134	3.4	0.165	4.2
NF1820	18"	120	1"	-2°	0.134	3.4	0.165	4.2
NF18150	18"	120	1"	-5°	0.110	2.8	0.150	3.8
NF50080	500mm	80	30mm	-5°	0.134	3.4	0.165	4.2
NF50010	500mm	100	30mm	-5°	0.134	3.4	0.165	4.2
NF50010-38	500mm	100	30mm	-5°	0.148	3.8	0.180	4.6
NF50020	500mm	120	30mm	-5°	0.134	3.4	0.165	4.2
NF50020-38	500mm	120	30mm	-5°	0.148	3.8	0.180	4.6
NF2040	20"	40	1"	0°	0.148	3.8	0.180	4.6
NF2060	20"	60	1"	0°	0.134	3.4	0.165	4.2
NF2080	20"	80	1"	-5°	0.134	3.4	0.165	4.2
NF2010	20"	100	1"	-5°	0.134	3.4	0.165	4.2
NF2010-38	20"	100	1"	-5°	0.148	3.8	0.180	4.6
NF20150P	20"	150	1"	5°	0.134	3.4	0.165	4.2
NF20180P	20"	180	1"	0°	0.134	3.4	0.165	4.2
NF2020	20"	120	1"	0°	0.134	3.4	0.170	4.3
NF55010	550mm	100	30mm	-5°	0.148	3.8	0.180	4.6
NF55020	550mm	120	30mm	-5°	0.134	3.4	0.180	4.2
NF55020-38	550mm	120	30mm	-5°	0.148	3.8	0.180	4.6
NF2260	22"	60	1"	-5°	0.148	3.8	0.180	4.6
NF2280	22"	80	1"	-5°	0.148	3.8	0.180	4.6
NF2210	22"	100	1"	-5°	0.148	3.8	0.180	4.6
NF2220	22"	120	1"	-5°	0.148	3.8	0.180	4.6
NF2460	24"	60	1"	5°	0.148	3.8	0.180	4.6
NF2480	24"	80	1"	-5°	0.148	3.8	0.180	4.6
NF2410	24"	100	1"	0°	0.148	3.8	0.180	4.6
NF2420	24"	120	1"	0°	0.134	3.4	0.165	4.2
NF24160	24"	160	1"	-5°	0.148	3.8	0.180	4.6
NF2648	26"	48	1"	0°	0.148	3.8	0.180	4.6
NF2660	26"	60	1"	0°	0.148	3.8	0.180	4.6
NF2672	26"	72	1"	0°	0.148	3.8	0.180	4.6
NF2680	26"	80	1"	0°	0.148	3.8	0.180	4.6

ASTRA SERIES PANEL SAWS

Metric Diameter MICRO-5 Tips

For use on various models of vertical and horizontal panel saw machines. MICRO-5 extra hard micro grain tips used on all panel saw blades.



Saw No.	Diameter	Teeth	Bore	Grind	Hook	Plate		Kerf		Pinholes
						Inch	mm	Inch	mm	
SP22064T5	220	64	30	TCG	5°	0.087	2.2	0.125	3.2	2/7/42
DFL2206430	220	64	30	30° ATB	-5°	0.087	2.2	0.115	2.9	2/7/42
SPE25080A5	250	80	30	ATB	15°	0.087	2.2	0.125	3.2	2/7/42
SPE25080T5	250	80	30	TCG	15°	0.087	2.2	0.125	3.2	2/7/42
DFL2508030	250	80	30	30° ATB	-5°	0.087	2.2	0.115	2.9	2/7/42; 2/10/60
SP30060A5	300	60	30	ATB	10°	0.095	2.4	0.134	3.4	2/10/60
SP30060T5	300	60	30	TCG	10°	0.118	2.4	0.134	3.4	2/10/60
SPE30072T5	300	72	30	TCG	5°	0.087	2.2	0.125	3.2	2/7/42; 2/10/60
SPE30010T5	300	100	30	TCG	5°	0.080	2.2	0.134	3.4	2/7/42; 2/10/60
DFL3001030	300	100	30	30° ATB	-5°	0.087	2.2	0.115	3.0	2/7/42; 2/10/60
TK35072T	350	72	30	TCG	13°	0.095	2.5	0.138	3.5	2/10/60
TK35072T1	350	72	1"	TCG	13°	0.095	2.5	0.138	3.5	2/10/60
SPE35072T3	350	72	30	TCG	13°	0.118	3.0	0.173	4.4	2/10/60
SPE35072T60	350	72	60	TCG	13°	0.118	3.0	0.173	4.4	2/10/60
SPE35072T80	350	72	80	TCG	13°	0.118	3.0	0.173	4.4	2/14/100
SPE38060T60	380	60	60	TCG	15°	0.125	3.2	0.175	4.4	As Required
SPE38072T60	380	72	60	TCG	13°	0.125	3.2	0.173	4.4	As Required
SPE38072T75	380	72	75	TCG	13°	0.125	3.2	0.173	4.4	As Required
SPE40072T30	400	72	30	TCG	13°	0.125	3.2	0.173	4.4	As Required
SPE40072T75	400	72	75	TCG	13°	0.125	3.2	0.173	4.4	As Required
SPE46072T30	460	72	30	TCG	13°	0.125	3.2	0.175	4.4	As Required
SPE48072T30	480	72	30	TCG	13°	0.125	3.2	0.175	4.4	As Required
SPE50072T60	500	72	60	TCG	13°	0.134	3.4	0.175	4.4	As Required
SPE500144A	500	144	30	TCG	10°	0.125	3.2	0.175	4.4	As Required

ASTRA SERIES SCORING SAWS – S

Straight Top and Conical Sides ▲

Used on both sliding carriage and beam type panel saws to score the bottom of panels, thus allowing large saw to cut through without chipping material on bottom side.

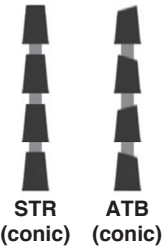

Saw No.	Diameter	Teeth	Bore	Grind	Hook	Plate		Kerf		Pinholes
						Inch	mm	Inch	mm	
S10020	100	20	5/8"	STR (conic)	8°					As Required
S42024	4"	20	5/8"	STR (conic)	8°					As Required
S12024	120	20	5/8"	STR (conic)	8°					As Required
S43424	4-3/4" (120)	24	5/8"	STR (conic)	10°					As Required
S12524	125	24	45	STR (conic)	10°					As Required
S524	5" (125)	24	5/8"	STR (conic)	8°	Thickness to	Ground To			As Required
S624	6" (150)	24	5/8"	STR (conic)	8°	Match Panel	Match Panel			As Required
S1603655	160	36	55	STR (conic)	5°	Saw	Saw			3/7/66
S1752845	175	28	45	STR (conic)	8°					As Required
S1803645	180	36	45	STR (conic)	8°					As Required
S2003620	200	36	20	STR (conic)	8°					As Required
S2003645	200	36	45	STR (conic)	8°					As Required
S2003665	200	36	65	STR (conic)	8°					2/9/110

SPLIT SCORING SAWS – SS

Straight Top

Used on sliding carriage panel saws to score the bottom of panels, thus allowing large saw to cut through without chipping material on bottom side. Shims are provided to adjust kerf to match large blade.

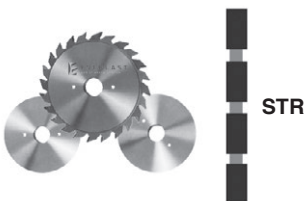

Saw No.	Diameter	Teeth	Bore	Grind	Kerf	
					Inch	mm
SS12012-34	120mm	2 x 12	3/4"/19.05mm	STR	.110 - .142	2.8 - 3.6
SS12012-20	120mm	2 x 12	20mm	STR	.110 - .142	2.8 - 3.6
SS12012-22	120mm	2 x 12	22mm	STR	.110 - .142	2.8 - 3.6
SS12012-50	120mm	2 x 12	50mm	STR	.110 - .142	2.8 - 3.6

TRACK SAW BLADES – FT

Metric Sizes with MICRO-5 Carbide Tips

These high-quality, industrial saws feature our Micro-5 carbide tips to provide 3 to 5 times longer life than standard carbide. Compatible with Festool and other track saw machines, these blades are ideal for cutting wood, melamine, aluminum, laminates, plastics and solid surface materials.

Saw No.	Body Dia.		Teeth	Bore (mm)	Grind	Hook	Plate		Kerf		Application
	mm	Inch					Inch	mm	Inch	mm	
FT16012A5	160	6.3	12	20	ATB	20°	0.062	1.6	0.087	2.2	Ripping
FT16028A5	160	6.3	28	20	ATB	15°	0.062	1.6	0.087	2.2	General Purpose
FT16048A5	160	6.3	48	20	ATB	5°	0.062	1.6	0.087	2.2	Double Face Laminate
FT16048T5	160	6.3	48	20	TC45	5°	0.062	1.6	0.087	2.2	Solid Surface
New FT16048T5NF	160	6.3	48	20	TCG	5°	0.062	1.6	0.087	2.2	Non Ferrous
FT21018A5	210	8.3	18	30	ATB	20°	0.072	1.8	0.102	2.6	Ripping
FT21036A5	210	8.3	36	30	ATB	15°	0.072	1.8	0.095	2.4	General Purpose
FT21052A5	210	8.3	52	30	ATB	8°	0.072	1.8	0.095	2.4	Double Face Laminate
FT21060T5	210	8.3	60	30	TC45	6°	0.072	1.8	0.095	2.4	Solid Surface
FT26060AR5	260	10.2	60	30	AR 4+1	-5°	0.072	1.8	0.098	2.5	General Purpose
FT26080AR5	260	10.2	80	30	AR 4+1	-2°	0.072	1.8	0.098	2.5	Mitre Cutting
New FT26080A5	260	10.2	80	30	ATB	-2°	0.072	1.8	0.098	2.5	Mitre Cutting
FT26080T5	260	10.2	80	30	TCG	-2°	0.072	1.8	0.098	2.5	Non Ferrous

COUNTERTOP SAW – CT

TC45

Designed to give highest quality, smoothest chip-free cuts on laminated post form countertops with backsplash. Ideally suited for post form countertop machines such as Midwest Automation and Edgetech.

Saw No.	Diameter	Teeth	Bore	Grind	Hook	Plate		Kerf	
						Inch	mm	Inch	mm
CT1620	16"	120	1"	TC45	-2°	0.118	3.000	0.148	3.800
† CT16205	16"	120	1"	TC45	-2°	0.118	3.000	0.148	3.800
† CT18205	18"	120	1"	TC45	-2°	0.134	3.400	0.175	4.400

† MICRO-5 extra hard tips provide 3 to 5 times longer service than standard carbide.

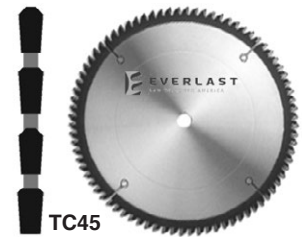

ASTRA SERIES SOLID SURFACE SAWS – DFLC

TC 45

Designed to provide seam quality cutting on solid surface materials such as Corian®, Staron®, Avonite®, etc. Special clearances provide a finish which requires virtually no sanding or polishing.

Saw No.	Diameter	Teeth	Bore	Grind	Hook	Plate		Kerf		Pinholes
						Inch	mm	Inch	mm	
DFLC71440	7-1/4"	40	5/8"	TC45	-2°	0.080	2.0	0.102	2.6	
DFLC860	8"	60	5/8"	TC45	-2°	0.087	2.2	0.110	2.8	
DFLC960	9"	60	5/8"	TC45	-5°	0.087	2.2	0.115	2.9	
† DFLC22064	220	64	30mm	TC45	-5°	0.087	2.2	0.115	2.9	2/7/42
† DFLC25080	250	80	30mm	TC45	-5°	0.087	2.2	0.115	2.9	2/7/42; 2/10/60
DFLC1060	10"	60	5/8"	TC45	-2°	0.087	2.2	0.110	2.8	
DFLC1080	10"	80	5/8"	TC45	-5°	0.087	2.2	0.110	2.8	
DFLC1080P	10"	80	5/8"	TC45	5°	0.087	2.2	0.110	2.8	
† DFLC30010	300	100	30mm	TC45	-5°	0.087	2.2	0.115	2.9	2/7/42; 2/10/60
(1) DFLC1280	12"	80	1"	TC45	-2°	0.080	2.0	0.118	3.0	
DFLC1280M	12"	80	30mm	TC45	-2°	0.080	2.0	0.118	3.0	2/7/42; 2/9/46; 2/10/60
(1) DFLC1210	12"	100	1"	TC45	-5°	0.095	2.4	0.118	3.0	
DFLC1210P	12"	100	1"	TC45	5°	0.095	2.4	0.118	3.0	
New (1) DFLC1410	14"	100	1"	TC45	-2°	0.118	3.0	0.148	3.8	

† MICRO-5 extra hard tips provide 3 to 5 times longer service than standard carbide.

(1) Available with 5/8" bore



Custom saws, grinds, bore sizes and pinholes available upon request.

DADO SETS – DS

Offers the woodworking shop one tool which will cut various size grooves up to 13/16 inch maximum width of cut. Can be used to cut either with or against grain. Fine Tooth Dado recommended for plywood, Melamine, or where extra smooth cut is needed.



Outside saws do NOT have a hub.

Saws with hubs available upon request.

All sets consist of:

Two (2) each - 1/8" outside blades

Four (4) each - 1/8" chippers

One (1) each - 1/16" chipper

Saw No.	Diameter	Teeth	Bore	Hook	Chipper		Cut Width
					Teeth Qty.		
DS618P58	6"	18	5/8"	15°	2		1/4" to 13/16"
DS618P1	6"	18	1"	15°	2		1/4" to 13/16"
DS824P58	8"	24	5/8"	15°	2		1/4" to 13/16"
DS824P1	8"	24	1"	15°	2		1/4" to 13/16"
DS830	8"	30	5/8"	-5°	2		1/4" to 13/16"
DS8301	8"	30	1"	-5°	2		1/4" to 13/16"
DS840	8"	40	5/8"	-5°	2		1/4" to 13/16"
DS8401	8"	40	1"	-5°	2		1/4" to 13/16"
DS1024P58	10"	24	5/8"	15°	4		1/4" to 13/16"
DS1024P1	10"	24	1"	15°	4		1/4" to 13/16"
DS1224P58	12"	24	5/8"	15°	4		1/4" to 13/16"
DS1224P1	12"	24	1"	15°	4		1/4" to 13/16"
DS1240P1	12"	40	1"	5°	4		1/4" to 13/16"

OUTSIDE DADO SAWS – OS DADO CHIPPERS – DC



Saw No.	Dia.	Teeth	Bore	Grind	Hook	Kerf
OS6L	6"	18	5/8"	Left	15°	1/8"
OS6R	6"	18	5/8"	Right	15°	1/8"
OS8L	8"	24	5/8"	Left	0°	1/8"
OS8R	8"	24	5/8"	Right	0°	1/8"
OS840L	8"	40	5/8"	Left	-5°	1/8"
OS840R	8"	40	5/8"	Right	-5°	1/8"
OS10L	10"	24	5/8"	Left	15°	1/8"
OS10R	10"	24	5/8"	Right	15°	1/8"
OS12L	12"	24	1"	Left	15°	1/8"
OS12R	12"	24	1"	Right	15°	1/8"



Saw No.	Dia.	Bore	Hook	Kerf
DC616	6"	5/8"	15°	1/16"
DC618	6"	5/8"	15°	1/8"
DC614	6"	5/8"	15°	1/4"
DC816N	8"	5/8"	-5°	1/16"
DC818N	8"	5/8"	-5°	1/8"
DC814N	8"	5/8"	-5°	1/4"
DC1016	10"	5/8"	15°	1/16"
DC1018	10"	5/8"	15°	1/8"
DC1014	10"	5/8"	15°	1/4"
DC1216	12"	1"	15°	1/16"
DC1218	12"	1"	15°	1/8"
DC1214	12"	1"	15°	1/4"

PALLET/NAIL CUTTING BLADES – NL UNI-TCG

Designed for pallet manufacturing and recycling operations, our Pallet / Nail Cutting Blades utilize heavy plate with a carbide designed to cut ferrous materials such as nails and staples.



Saw No.	Diameter	Teeth	Bore	Grind	Hook	Plate		Kerf	
						Inch	mm	Inch	mm
NL1024	10"	24	5/8"	UNI-TCG	-5°	0.095	2.4	0.148	3.8
NL1224-28	12"	24	1"	UNI-TCG	-5°	0.110	2.8	0.180	4.6
NL1224-34	12"	24	1"	UNI-TCG	-5°	0.134	3.4	0.200	5.1
NL1228	12"	24	1"	UNI-TCG	-5°	0.118	3.0	0.180	4.6
NL1424	14"	24	1"	UNI-TCG	-5°	0.118	3.0	0.180	4.6
New NL1430-34	14"	30	1"	UNI-TCG	-5°	0.134	3.4	0.200	5.1
NL1630	16"	30	1"	UNI-TCG	-5°	0.134	3.4	0.192	4.9
NL1824	18"	24	1"	UNI-TCG	-5°	0.134	3.4	0.192	4.9
NL1836	18"	36	1"	UNI-TCG	-5°	0.134	3.4	0.192	4.9

GROOVER – GRO

Straight Top

A single purpose tool to be used when a specific width of groove is desired for production runs. Will provide good finish cuts when run with grain of material. Hook angle for standard groovers 5/16" kerf and smaller is +10 degrees. Hook angle for 3/8" kerf groovers is +15 degrees.

Groover No.	Diameter	Kerf	Teeth	Bore
G4184	4"	1/8"	4	5/8"
G43164	4"	3/16"	4	5/8"
G4144	4"	1/4"	4	5/8"
G6188	6"	1/8"	8	5/8"
G63168	6"	3/16"	8	5/8"
G6148	6"	1/4"	8	5/8"
G65168	6"	5/16"	8	5/8"
G6388	6"	3/8"	8	5/8"
G6128	6"	1/2"	8	5/8"
G831612	8"	3/16"	12	5/8"
G81412	8"	1/4"	12	5/8"
G851612	8"	5/16"	12	5/8"
New G83812	8"	3/8"	12	5/8"
G81424	8"	1/4"	24	5/8"
G83824	8"	3/8"	24	5/8"
New G81224	8"	1/2"	24	5/8"
G1031624	10"	3/16"	24	5/8"
G101424	10"	1/4"	24	5/8"
G1051624	10"	5/16"	24	5/8"
G103824	10"	3/8"	24	5/8"

Optional Top Grinds

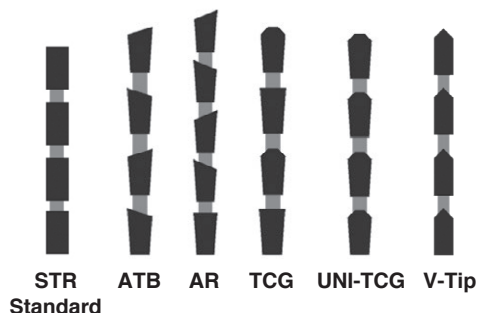

Please call for:
 Different Number of Teeth
 Shear Face
 Special Designs
 Special Bore Size
 Alternate Top Grinds

Groover No.	Diameter	Kerf	Teeth	Bore
G121412	12	1/4"	12	5/8"
G121424	12	1/4"	24	5/8"
G121430	12	1/4"	30	5/8"
G123812	12	3/8"	12	5/8"
G123824	12	3/8"	24	5/8"
G121210	12	1/2"	10	5/8"
G121212	12	1/2"	12	5/8"
G121224	12	1/2"	24	5/8"

EDGE BANDER SAWS – EB

Alternate Top Bevel or All Teeth Beveled to Left or Right

A specially designed saw for both single or two sided edge banding machines, for the end trimming of either wood or plastic banding materials.

Saw No.	Diameter	Teeth	Bore	Hook	Plate		Kerf	
					Inch	mm	Inch	mm
EB420	4"	20	5/8"	8°	.085	2.2	.125	3.2
EB4200	4"	20	5/8"	0°	.085	2.2	.125	3.2
EB4524	4-1/2"	24	5/8"	10°	.085	2.2	.125	3.2
EB43424	4-3/4"	24	5/8"	10°	.085	2.2	.125	3.2
EB524	5"	24	5/8"	8°	.085	2.2	.125	3.2
EB5530	5-1/2"	30	5/8"	6°	.085	2.2	.125	3.2
EB640	6"	40	5/8"	6°	.085	2.2	.125	3.2
EB6400	6"	40	5/8"	0°	.085	2.2	.125	3.2

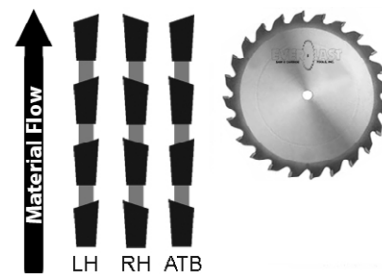

NOTE: When ordering Alternate Top Bevel add letter A after Saw No.
 For Left Bevel add letter L after Saw No. For Right Bevel add letter R after Saw No.

Specify bevel direction with saw teeth coming at you.

BISCUIT CUTTER BLADE – LAM

Alternate Top Bevel

Replacement blade for most biscuit jointers such as Lamello, Virutex, etc.

Saw No.	Diameter	Teeth	Bore	Grind	Hook	Plate		Kerf
						Inch	mm	mm
LAM10012	100mm	12	22mm	ATB	15°	.118	3.0	4



Custom saws, grinds, bore sizes and pinholes available upon request.

BALL BEARINGS – EB



Part Number	Outside Diameter	Inside Diameter
EB-01	3/8"	1/8"
EB-02	1/2"	3/16"
EB-03	.865	5/16
EB-04	1/4"	1/8"
EB-05	3/8"	3/16"
EB-06	1/2"	1/4"
EB-07	5/8"	3/16"
EB-08	5/8"	1/4"
EB-09	3/4"	3/16"
EB-10	3/4"	1/4"
EB-11	1-1/8"	1/2"

SHIMS

Item Number	Arbor	OD	Type	Qty/Thickness
ShimKitMag58	5/8"	3.8"	Magnetic	2 ea .010"
				2 ea .012"
				2 ea .015"
ShimKitMag01	1"	3.8"	Magnetic	2 ea .010"
				2 ea .012"
				2 ea .015"

Steel shims available. Call Everlast for your specific needs.

SLOTTING CUTTERS – EGS

Tool Number	Number of Wings	Standard Kerf	Cutter Diameter	Standard Hole
EGS-316	3	1/16"	2"	5/16"
EGS-370	3	.070	2"	5/16"
EGS-380	3	.080	2"	5/16"
EGS-393	3	3/32"	2"	5/16"
EGS-318	3	.125	2"	5/16"
EGS-3316	3	3/16"	2"	5/16"
EGS-314	3	1/4"	2"	5/16"
EGS-416	4	1/16"	2"	5/16"
EGS-470	4	.070	2"	5/16"
EGS-480	4	.080	2"	5/16"
EGS-493	4	3/32"	2"	5/16"
EGS-418	4	.125	2"	5/16"
EGS-4316	4	3/16"	2"	5/16"
EGS-616	6	1/16"	2"	5/16"
EGS-670	6	.070	2"	5/16"
EGS-680	6	.080	2"	5/16"
EGS-693	6	3/32"	2"	5/16"
EGS-618	6	.125	2"	5/16"
EGS-6316	6	3/16"	2"	5/16"
EGS-614	6	1/4"	2"	5/16"

DIAMOND GRINDING WHEELS – DGW

Item Number	Dia. (mm)	Arbor (mm)	Grit	Applications
12V2	150	32	240	Facing Akemat B, excellent design for saws with small tooth pitch
4A1	100	20	180	Akemat Model F, F2, F3 Side Grinders.
4A2P	150	1.25"	220	Facing
AK125	125	32	150/220/600	Top grinding on Akemat U4 models.
VOL125	125	32	150/400	Top grinding on Vollmer CX100.



TREE TRIMMING SAWS

TRE

Special plate is used for these saws which are designed for use with tree trimming machines. Plates typically do not have expansion slots. Add "SL" to end of Saw Number if expansion slots are required.

	Saw No.	Diameter	Teeth	Bore	Grind	Hook	Plate (in.)	Kerf (in.)
New	TRE2060	20	60	1.5"	ATB	10°	0.148	0.235
	TRE2080	20	80	1"	ATB	10°	0.148	0.209
	TRE2472-NS	24	72	1.5"	ATB	10°	0.180	0.260
	TRE2472-SL	24	72	1.5"	ATB	10°	0.180	0.260

TRUSS AND COMPONENT SAWS – TC

ATB/TCG

These saws are the workhorses of truss plants and are designed to provide a long service life and excellent cutting performance. Countersunk (82 deg) holes will accept 5/16" flat head bolt.

Machine Mfg	Saw No.	Dia.	Teeth	Bore	Grind	Hook	Plate		Kerf		Bolt Hole Circle Dia.	Countersink 82 deg	
							Inch	mm	Inch	mm		Left	Right
Alpine Linear	TC2010	20"	100	1.5"	ATB	10°	0.150	3.8	0.225	5.7	None		
	TC20510	20.5"	100	1.5"	ATB	10°	0.150	3.8	0.225	5.7	5.25"		8
Auto Omni	TCK1240A	12"	40	0.875"	ATB	15°	0.094	2.4	0.142	3.6	2.25"	3	3
	TCK2040A	20"	40	1.5"	ATB	10°	0.150	3.8	0.200	5.1	3.50"	4	4
	TCK2040T	20"	40	1.5"	TCG	10°	0.150	3.8	0.200	5.1	3.50"	4	4
	TCK3080	30"	80	1.5"	TCG	10°	0.200	5.1	0.260	6.6	6.00"	6	6
Clary	TC1440A	14"	40	1"	ATB	10°	0.134	3.4	0.185	4.7	3.125"	3	3
	TC1440T	14"	40	1"	TCG	10°	0.134	3.4	0.185	4.7	3.125"	3	3
	TC1460T	14"	60	1"	TCG	10°	0.134	3.4	0.185	4.7	3.125"	3	3
	TC1640T	16"	40	1"	TCG	10°	0.134	3.4	0.185	4.7	3.125"	3	3
	TC1660T	16"	60	1"	TCG	10°	0.134	3.4	0.185	4.7	3.125"	3	3
	TC1860A	18"	60	1"	ATB	10°	0.150	3.8	0.209	5.3	3.125"	3	3
	TC1860T	18"	60	1"	TCG	10°	0.150	3.8	0.209	5.3	3.125"	3	3
	TC2060T	20"	60	1"	TCG	10°	0.150	3.8	0.209	5.3	3.125"	3	3
	TC2080A	20"	80	1"	ATB	10°	0.150	3.8	0.209	5.3	3.125"	3	3
	TC2280T	22"	80	1"	TCG	10°	0.150	3.8	0.209	5.3	5.00"		6
New	TC2212A	22"	120	1"	ATB	10°	0.150	3.8	0.209	5.3	5.00"		6
	TC3280T	32"	80	2"	TCG	10°	0.200	5.1	0.260	6.6	7.00"	6	
New	Hundegger TCHN65096	650mm	96	30mm	ATB	10°	0.150	3.8	0.220	5.6	90mm 100mm		
	TCHN70084	700mm	84	30mm	ATB	10°	0.165	4.2	0.245	6.2	2/14/400 4/8.5/90		
Idaco	TCID1440T	14"	40	1"	TCG	10°	0.134	3.4	0.185	4.7	6.00"	3	3
	TCID1660T	16"	60	1"	TCG	10°	0.134	3.4	0.185	4.7	6.00"	3	3
	TCID2060T	20"	60	1"	TCG	10°	0.150	3.8	0.209	5.3	6.00"	3	3
Koskovich	TCK1640K19	16"	40	0.875"	ATB	10°	0.150	3.8	0.190	4.8	2.25" 2.265"		
	TCK1640T25A	16"	40	1.26"	ATB	10°	0.150	3.8	0.190	4.8	2.25" 2.265"		
	TCK1640T25	16"	40	1.26"	TCG	10°	0.150	3.8	0.190	4.8	2.25" 2.265"		
Mangotech	TCM4504035	450mm	40	35mm	ATB	10°	0.134	3.4	0.175	4.7	None		
	TCM4506035	450mm	60	35mm	ATB	10°	0.134	3.4	0.175	4.7	None		
New	MCMK1650T	16"	50	1.125"	TCG	5°	0.146	3.7	0.202	4.2	6.00"	3	3
	TCS1740N	17"	40	50mm	ATB	10°	0.150	3.8	0.189	4.2	6/64mm		6
	TCMK2060	20"	60	1.125"	TCG	10°	0.150	3.8	0.200	5.1	6.00"	3	3
	TCMK3280L	32"	80	1.375"	TCG	10°	0.200	5.1	0.260	6.6	6.00"	6	
	TCMK3280R	32"	80	1.375"	TCG	10°	0.200	5.1	0.260	6.6	6.00"		6
New	TCDS1640	16"	40	1"	TCG	10°	0.134	3.4	0.185	4.7	4.00"	4	4
	TCDS1660A	16"	60	1"	ATB	10°	0.134	3.4	0.185	4.7	4.00"	4	4
	TCDS1840-34	18"	40	1"	TCG	15°	0.134	3.4	0.185	4.7	4.00"	4	4
	TCDS2260	22"	60	2"	TCG	10°	0.150	3.8	0.200	5.1	4.00"	4	4
	TCDS2280	22"	80	1.75"	TCG	10°	0.150	3.8	0.209	5.3	4.00"	4	4
	TCDS2480A	24"	80	2"	ATB	10°	0.150	3.8	0.209	5.3			
Razer	TCDS3080T	30"	80	1.625"	TCG	10°	0.150	3.8	0.209	5.3	6.00"	6	
	TCAZ35054A4	14"	54	50mm	ATB	10°	0.110	2.8	0.157	4.0	6/64mm		
Timber Mill	TCAZ35054T4	14"	54	50mm	TCG	10°	0.110	2.8	0.157	4.0	6/64mm		
	TCTM1440T	14"	40	1"	TCG	10°	0.134	3.4	0.185	4.7	3.50"	3	3
	TCTM1660T	16"	60	1"	TCG	10°	0.134	3.4	0.185	4.7	3.50"	3	3
	TCTM2080TRS	20"	80	1"	TCG	10°	0.150	3.8	0.209	5.3	5.00"		6
	TCTM2280R	22"	80	1"	TCG	10°	0.150	3.8	0.209	5.3	4.75"		6
	TCTM2280L	22"	80	1"	TCG	10°	0.150	3.8	0.209	5.3	4.75"	6	
	TCTM3080TL	30"	80	1.125"	TCG	10°	0.200	5.1	0.260	6.6	6.00"	6	
TCTM3080TR	30"	80	1.125"	TCG	10°	0.200	5.1	0.260	6.6	6.00"		6	
New	Triad TCIAD3080A	30"	80	1.5"	ATB	10°	0.200	5.1	0.260	6.6	3.00"	2 ea. 5/8" dia.	
	TCIAD3080T	30"	80	1.5"	TCG	10°	0.200	5.1	0.260	6.6	3.00"	No Countersink	
XL-Saw	TCTCT1640A	16"	40	2.5"	ATB	10°	0.134	3.4	0.185	4.7	4/.40"/6.0"		

Materials
from around
the world.

*Quality made
in America.*

Since 1947.

Standard and custom
saw blades and groovers
up to 36"

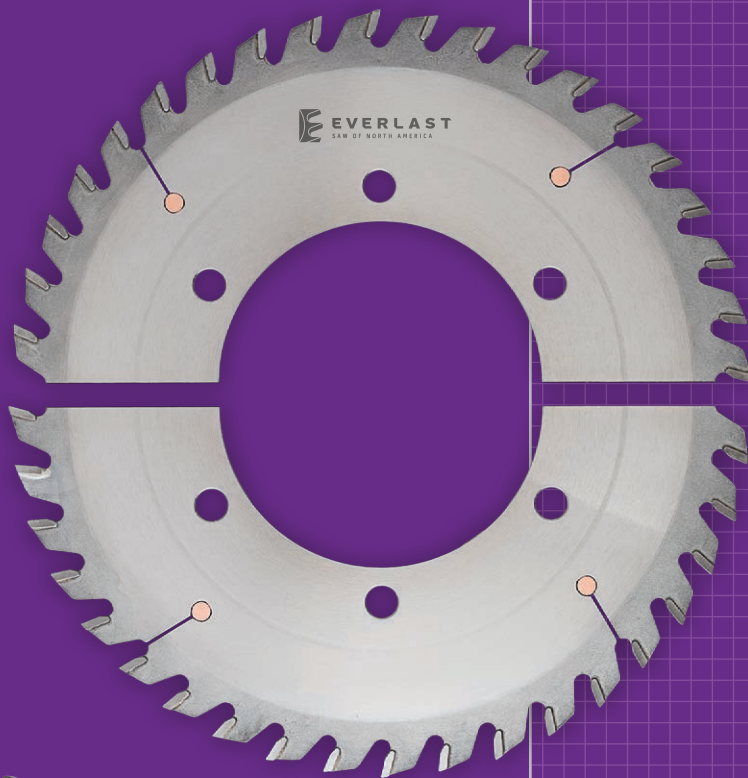

Custom bores,
pinholes, standard
and reverse keyways,
split blades available.



418 NORTH POPLAR | SOUTH HUTCHINSON | KS 67505

800-387-5278 | 239-596-3333 | FAX 239-596-9616

EVERLASTSAW.COM

